



OFYR



01 **Line-up** 8

02 **Plancha** 10

03 **Kamado** 16

04 **Mise en Place** 22

05 **Bridge** 28



The
ultimate
outdoor
kitchen
solution



The OFYR PRO Connect redefines outdoor cooking by seamlessly combining preparation and cooking in a single, modular system.

This innovative design connects individual units with a bridge, creating an expansive and versatile workspace that suits your needs. Whether you're hosting an intimate gathering or catering a large event, the OFYR PRO Connect provides the flexibility and functionality to prepare, cook, and serve with ease.

The extended working surface not only enhances your cooking possibilities but also creates a welcoming space for people to gather, socialize, or even join in the culinary process. Designed with mobility and flexibility in mind, the OFYR PRO Connect offers a choice between sturdy feet for permanent installations or wheels for easy movement. This makes it ideal for both restaurants and catering professionals, allowing you to adapt to temporary event setups or establish a more permanent cooking solution.

Whether stationary or mobile, the OFYR PRO Connect combines practicality with a sleek, sophisticated design that fits seamlessly into any environment. It's the ultimate tool for modern chefs who value style, versatility, and innovation.





01

LINE-UP

Stationary or mobile

Offers two setup options: stationary feet or wheels. This means the OFYR PRO Connect can serve as either a permanent installation or a mobile unit. You can also combine both options - using stationary feet for a stable working space with the Kamado Table while keeping the OFYR Plancha unit mobile.

Seamless expansion

A standout feature of the OFYR PRO Connect is the bridge system, designed to seamlessly connect multiple units. This modular addition allows you to expand your cooking area, creating a larger workspace tailored to your needs.

Durable & refined

The base of the OFYR PRO Connect is made from powder-coated aluminium with a fine structure finish, ensuring longlasting quality and a sophisticated look. The working surface is made of Dekton, a high-quality material known for its heat resistance and easy-to-clean properties.

Colour Combinations

Available in two colour combinations, in Taupe with light Dekton and in Black with dark Dekton.



OFYR PRO CONNECT TAUPE



OFYR PRO CONNECT BLACK

02

PLANCHA MODULE

The **OFYR PRO Connect** Plancha Module is the ultimate centerpiece for outdoor chefs who value design, performance and longevity in perfect balance. With its generous 100 cm cooking surface and smart airflow system, this unit delivers a seamless cooking experience that lasts for hours.

The innovative air circulation ensures fast ignition, even heat distribution and minimal smoke—ideal for social, stress-free outdoor moments. A thermally insulated cone keeps the base cool and steady, even during extended use.

Crafted from premium aluminium and stainless steel, the Plancha is weather-resistant, easy to maintain and built for life outdoors. The removable ash tray allows for effortless cleaning after every use.



KEY FEATURES



Durable & Lightweight

The Plancha Cooking Unit, made from aluminium and stainless steel, guarantees long-lasting durability while keeping the product much lighter and easier to handle.

Easy Cleaning

The removable ash tray is designed for quick and effortless maintenance, ensuring the unit stays in top condition with minimal effort.

Limited Heat Transfer

The disconnected plancha nest reduces the amount of heat transferred to the base, keeping the structure safer and more comfortable to use.

Full Mobility

Equipped with a handle, knobs, wheels, and legs, the design makes the unit easy to move, adjust, and position wherever needed.

COLOURS & FINISHES



TAUPE
RAL 7006



PLANCHA MODULE
TAUPE WITH LEGS



PLANCHA MODULE
TAUPE WITH WHEELS



BLACK
RAL 9004



PLANCHA MODULE
BLACK WITH LEGS



PLANCHA MODULE
BLACK WITH WHEELS



SPECS

COMPONENT	WEIGHT	MATERIAL
PLANCHA COOKING MODULE	127 KG	
BASE SINGLE	29.3 KG	ALUMINIUM (3MM)
HANDLE	3.2 KG	ALUMINIUM
TOP PLATE	6.6 KG	STAINLESS STEEL
ASH TRAY	5.2 KG	ALUMINIUM + STAINLESS STEEL
CONE	17.5 KG	STEEL
COOKING PLATE	55.6 KG	STEEL
NEST RING	4.0 KG	STAINLESS STEEL
KNOBS (SET)	0.12 KG	STAINLESS STEEL
LEGS (SET) / WHEELS (SET)	4.2 KG / 5.4 KG	STAINLESS STEEL

DIMENSIONS	MM
COOKING HEIGHT	985MM
PREP HEIGHT	905MM
BASE (W X D)	700X700MM

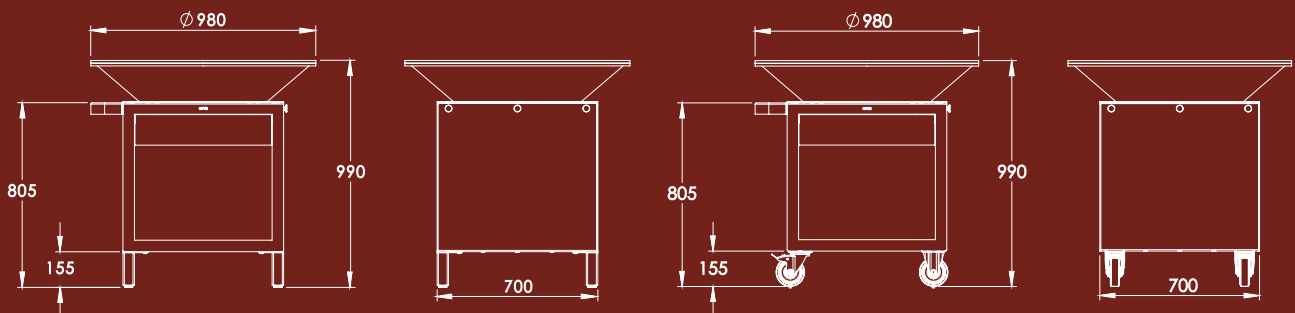

03

KAMADO MODULE

The **OFYR PRO Connect** Kamado Table featuring The Bastard PRO/BSTRD. PRO Graphite is the ideal choice for outdoor chefs who demand precision, power, and modular design in one refined unit. Built for performance and versatility, it offers a solid base for the ultimate kamado cooking experience.

The frame is constructed from lightweight yet durable aluminium and stainless steel - resilient to weather and built to move. A secure locking system ensures your kamado stays firmly in place, even when repositioning your setup.

The removable Dekton worktop adds a sleek, heat-resistant and scratchproof surface that is easy to clean and designed to withstand the rigours of outdoor use. Whether you choose wheels or fixed legs - both included - you remain fully in control of your ideal setup.



KEY FEATURES



Durable & Lightweight

The Kamado Cooking Unit is constructed using a blend of aluminium and stainless steel, guaranteeing long-lasting quality while making the unit lighter and easier to use.

Enhanced Stability

The improved nest design ensures that the kamado remains steady and secure, both during transportation and while in use.

Fixed Countertop

The fixated countertop prevents any unwanted movement, providing extra safety and reliability during transport and use.

Easy Cleaning

The detachable countertop allows for quick and effortless cleaning, making maintenance simple and efficient.

Full Mobility

Equipped with a bridge, handle, knobs, wheels, and legs, the Connect design makes the unit easy to move, adjust, and position wherever needed.

COLOURS & FINISHES



LIGHT SAND
AVA



TAUPE
RAL 7006



KAMADO MODULE
TAUPE WITH LEGS



KAMADO MODULE
TAUPE WITH WHEELS



DARK ASH
SIRIUS



BLACK
RAL 9004



KAMADO MODULE
BLACK WITH LEGS



KAMADO MODULE
BLACK WITH WHEELS



SPECS

COMPONENT	WEIGHT	MATERIAL
KAMADO MODULE	53 KG	
KAMADO PRO LARGE SOLO	103 KG	
BASE SINGLE	29.3 KG	ALUMINIUM (3MM)
HANDLE	3.2 KG	ALUMINIUM
COUNTERTOP BOX SINGLE	4.0 KG	ALUMINIUM
KAMADO NEST	4.7 KG	ALUMINIUM
COUNTERTOP	6.4 KG	DEKTON (12MM)
CENTRING BRACKETS	0.3 KG	STAINLESS STEEL
KNOBS (SET)	0.12 KG	STAINLESS STEEL
LEGS (SET)	4.2 KG	STAINLESS STEEL
WHEELS (SET)	5.4 KG	STAINLESS STEEL

DIMENSIONS	MM
COOKING HEIGHT	985MM
PREP HEIGHT	905MM
BASE (W X D)	700X700MM

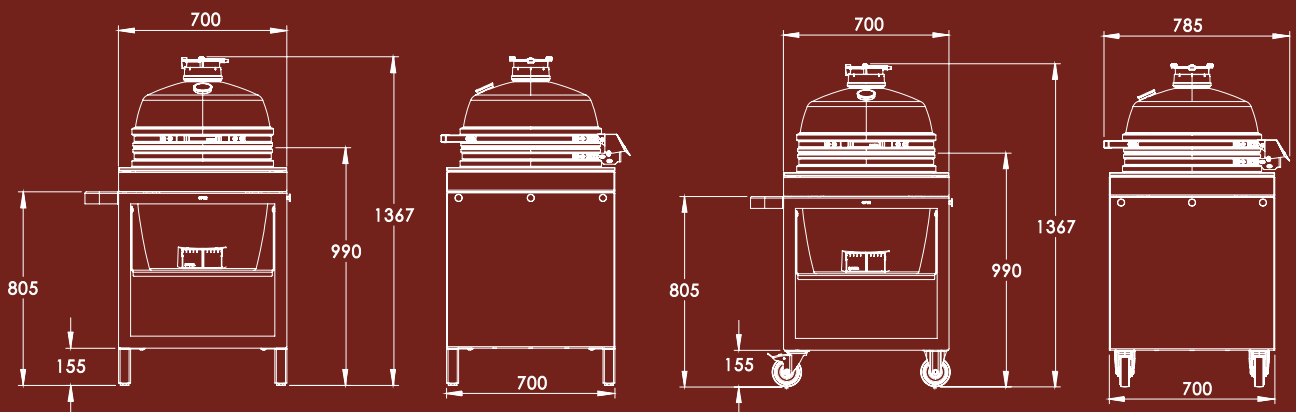

04

MISE EN PLACE MODULE

The **OFYR PRO Connect** Mise en Place Module is where thoughtful design meets daily function - perfect for preparation, organisation, and outdoor flow. Whether you're prepping ingredients or plating up, this workstation becomes the quiet hero of your cooking ritual.

A removable Dekton surface offers a durable, heat- and scratch-resistant workspace that's easy to clean. Beneath, integrated storage keeps tools, herbs, and accessories within reach, so you can work efficiently and stay in the moment.

Made from premium aluminium and stainless steel, this unit is weatherproof, lightweight and built for outdoor living. It comes with both wheels and fixed legs included, so you can adapt the setup to your preference and layout.



KEY FEATURES



Durable & Lightweight

The Mise en Place Unit combines aluminium and stainless steel in its construction, providing excellent durability while remaining significantly lighter to handle.

Practical Storage

The unit offers convenient temporary storage space, making it easy to keep essential tools and ingredients within reach.

Fixed Countertop

The fixated countertop prevents any unwanted movement, providing extra stability and reliability during transport and use.

Easy Cleaning

The detachable countertop allows for quick and effortless cleaning, making maintenance simple and efficient.

Full Mobility

Equipped with a bridge, handle, knobs, wheels, and legs, the design makes the unit easy to move, adjust, and position wherever needed.

COLOURS & FINISHES



LIGHT SAND
AVA



TAUPE
RAL 7006

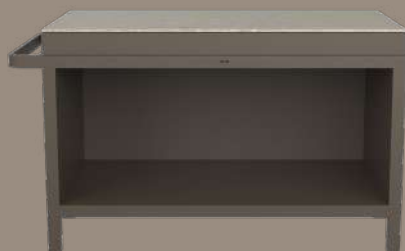

MISE EN PLACE MODULE
TAUPE WITH LEGS

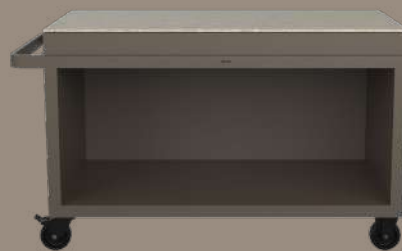

MISE EN PLACE MODULE
TAUPE WITH WHEELS



DARK ASH
SIRIUS



BLACK
RAL 9004



MISE EN PLACE MODULE
BLACK WITH LEGS



MISE EN PLACE MODULE
BLACK WITH WHEELS



SPECS

COMPONENT	WEIGHT	MATERIAL
MISE EN PLACE MODULE	98 KG	
BASE DOUBLE	49.3 KG	ALUMINIUM (3MM)
HANDLE	3.2 KG	ALUMINIUM
COUNTERTOP BOX DOUBLE	11.4 KG	ALUMINIUM
COUNTERTOP	30 KG	DEKTON (12MM)
KNOBS (SET)	0.12 KG	STAINLESS STEEL
LEGS (SET)	4.2 KG	STAINLESS STEEL
WHEELS (SET)	5.4 KG	STAINLESS STEEL

DIMENSIONS	MM
COOKING HEIGHT	985MM
PREP HEIGHT	905MM
BASE (W X D)	700X1400MM

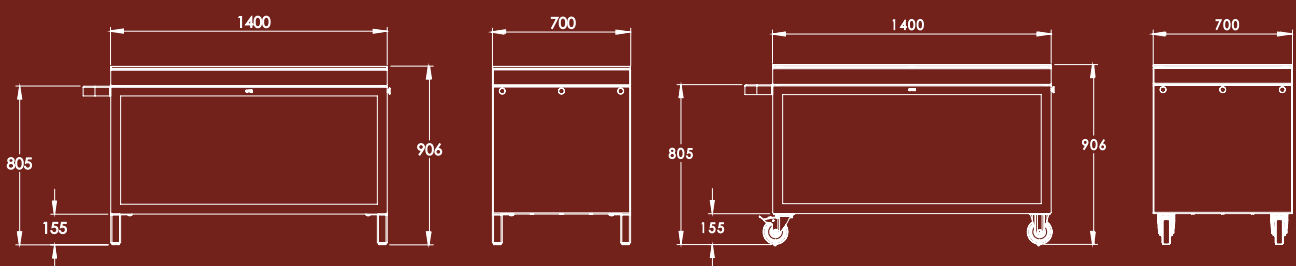

05

BRIDGE MODULE

The **OFYR PRO Connect** Bridge Module is the elegant link that ties your cooking units together. It transforms standalone modules into a unified workspace with visual flow and added functionality.

Its premium Dekton top provides a durable, heat-resistant surface that's ideal for preparation or serving. Easy to clean and highly refined, the Bridge enhances not just your layout, but also your workflow.

Crafted from lightweight aluminium, this module is easy to move and designed for longevity. It is purpose-built to connect other PRO Connect elements - such as the Mise en Place or Kamado Table - into a seamless configuration.



KEY FEATURES



Durable & Lightweight

The Bridge Unit, made from aluminium, guarantees long-lasting durability while keeping the product much lighter and easier to handle.

Extended Workspace

The unit expands the available working space and creates more opportunities to socialize and connect while cooking.

Fixed Countertop

The fixated countertop prevents any unwanted movement, providing extra stability and reliability during transport and use.

Easy Cleaning

The detachable countertop allows for quick and effortless cleaning, making maintenance simple and efficient.

Seamless Connection

The Bridge Module easily connects with the Kamado Cooking Unit and the Mise en Place Unit using the included flange screws.

COLOURS & FINISHES



LIGHT SAND
AVA



TAUPE
RAL 7006



BRIDGE MODULE
TAUPE



DARK ASH
SIRIUS



BLACK
RAL 9004



BRIDGE MODULE
BLACK







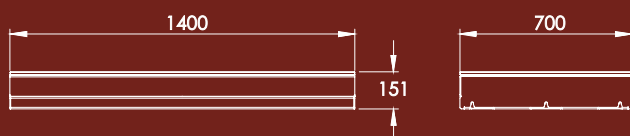

SPECS

COMPONENT	WEIGHT	MATERIAL
BRIDGE MODULE	44 KG	
BRIDGE BASE	14.0 KG	ALUMINIUM (3MM)
COUNTERTOP	30 KG	DEKTON (12MM)

DIMENSIONS	MM
PREP HEIGHT	905MM
BASE (W X D)	700X1400MM

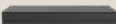

PRODUCT LIST

	ITEM	EAN	SKU
	OFYR PRO CONNECT PLANCHA MODULE TAUPE	8720882127344	OKP1T
	OFYR PRO CONNECT PLANCHA MODULE BLACK	8720882127337	OKP1B
	OFYR PRO CONNECT TAUPE X THE BASTARD PRO GRAPHITE	8720882129775	OKP2G1T
	OFYR PRO CONNECT BLACK X THE BASTARD PRO GRAPHITE	8720882129768	OKP2G1B
	OFYR PRO CONNECT MISE EN PLACE MODULE TAUPE	8720882127429	OKP3T
	OFYR PRO CONNECT MISE EN PLACE MODULE BLACK	8720882127412	OKP3B
	OFYR PRO CONNECT BRIDGE MODULE TAUPE	8720882127467	OKP4T
	OFYR PRO CONNECT BRIDGE MODULE BLACK	8720882127450	OKP4B





Exceptional Outdoor Moments



PT MULTI FLASHINDO KARISMA

□ JAKARTA (Head Office)

Jl. Hayam Wuruk 114 Blok A No. 4
Maphar, Jakarta - Indonesia 11160
Telepon : +62 21 626 8758
Whatsapp : +62 811 1210 6803
Email : sales.dept@mfk.co.id

□ SURABAYA

Ruko Royal Crown Palace RA 2
Jl. H. Anwar Hamzah, Kp. Baru, Tambakoso,
Kec. Waru, Kab. Sidoarjo, Jawa Timur 61256
Telepon : +62 31 3592 9091
Whatsapp : +62 811 1210 6803
Email : sales.sby@mfk.co.id

□ BALI

Jl. Sunset Road No.108 B, Kec. Kuta
Kel. Badung, Bali - Indonesia 80361
Telepon : +62 361 934 2633
Whatsapp : +62 811 1210 6803
Email : sales.bali@mfk.co.id

□ SERVICE CENTER

Jl. Kamal Raya No.9 Unit B. RT 01/ RW 06
Tegal Alur, Cengkareng - Indonesia 11820
Telepon : +62 21 5595 2523
Whatsapp : +62 811 9144 614
Email : service.center@mfk.co.id